

RS

SNCF Agence des Gares - Jean-Marie Duthilleul
.98

RS



INTRO

The RS seating system provides the perfect solution for all large waiting areas. It is especially suited to railway stations; the intended application of the original design created by Jean-Marie Duthilleul in conjunction with AREP. The product's versatility and its availability in a choice of finishes offering different images, led to it becoming an instant success and finding deployment as street furniture and as seating in spaces like airports, underground railway interchanges and bus and tram stations.

RS is a modular system of individual seats that can be combined and assembled on bars to form groups of two to five chairs. The bases, connecting mechanisms and armrests are made in die-cast aluminium. The seats themselves come in various finishes including aluminium with wood slats, steel, teak, wenge and black leather. Like the bases, the extruded bar that supports the seats is specially treated for strength and resistance to vandalism. The RS collection also includes accessory tables in two colours of back-painted glass or in black laminate and a continuous bench made from wood slats, with or without backrest. The result is an extremely flexible seating system that is ideal for use indoors and out.

DESIGNER



Jean Marie Duthilleul

RS

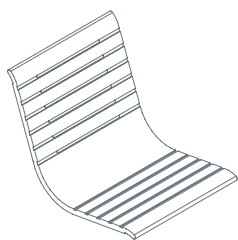

Painted die-cast aluminium shell
or painted steel shell
1RS5511: L 20½ D 25½ H 19 (aluminium)
1RS5541: L 20½ D 25½ H 19 (painted steel)

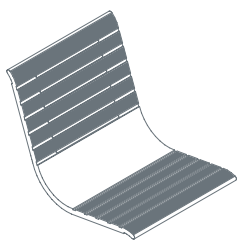

Wooden slats shell
1RS5521: L 20½ D 25½ H 19

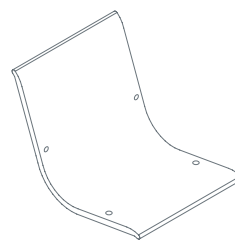

Curved wood shell
1RS5551: L 20½ D 25½ H 19

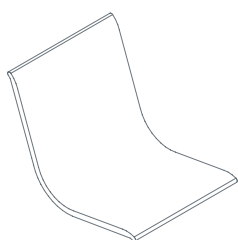

Black leather shell
1RS5561: L 20½ D 25½ H 19

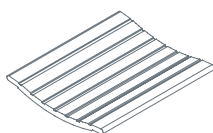

Painted die-cast aluminium shell
1RS5571: L 20½ D 17¾ H 2½

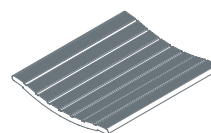

Wooden slats shell
1RS5581: L 20½ D 17¾ H 2½

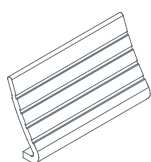

Painted die-cast aluminium shell
1RS5591: L 20 D 10¼ H 9½

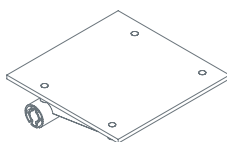

Black laminate table
1RS1511FL: L 20½ D 20½ H 0½

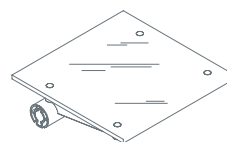

Painted tempered glass table
1RS1511CW: L 20½ D 20½ H 0½

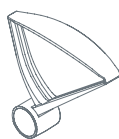

Flat armrests in polished or painted aluminium



Angled armrests in polished or painted aluminium



Armrest in polished or painted aluminium

RS



Aluminium base (Not for 1RS5591)
1RS1541: L 4¾ D 13

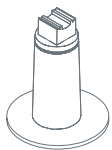

Disc type aluminium base (Not for 1RS5591)
1RS1521: L 10 D 13½

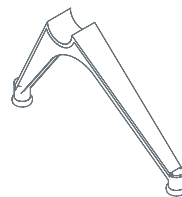

Mobile base (Not for 1RS5571/81/91)
1RS1561: L 3 D 23 H 12¾



Aluminium base for high bench 1RS5591
1RS1551: L 4 D 24½

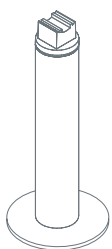

Disc type aluminium base for high bench 1RS5591
1RS1531: L 10 D 24¾



Mobile base 1RS5571/81
1RS1571: L 3 D 17¼ H 12¾

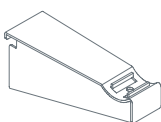

Aluminium wall mounted bracket
1RS1581: L 12 D 33

RS

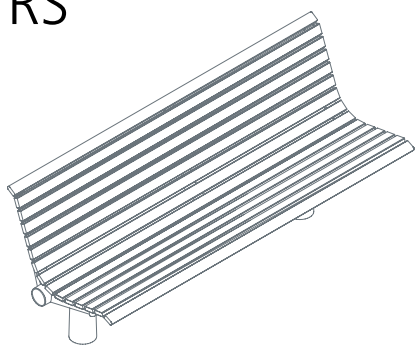

Bench, three seats with wooden slats and fixed base

1RS5601: L 72½ D 24¾ H 32¾

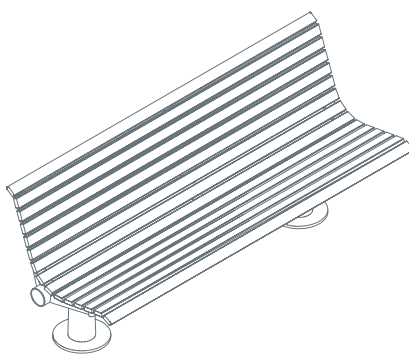

Bench, three seats with wooden slats and base for fixing to floor by disc

1RS5602: L 72½ D 24¾ H 32¾

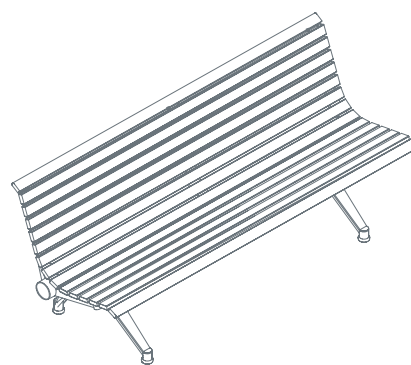

Bench, three seats with wooden slats and mobile base

1RS5603: L 72½ D 24¾ H 32¾

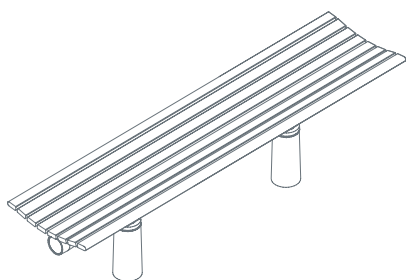

Backless bench, three seats with wooden slats and fixed base

1RS5611: L 72½ D 17¾ H 17¾

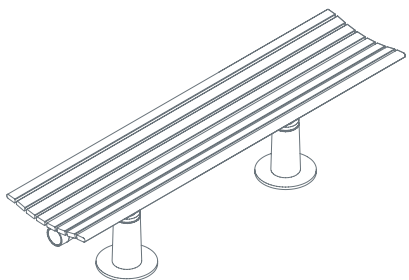

Backless bench, three seats with wooden slats and base for fixing to floor by disc

1RS5612: L 72½ D 17¾ H 17¾

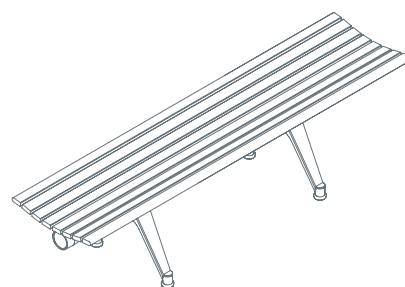

Backless bench, three seats with wooden slats and mobile base

1RS5613: L 72½ D 17¾ H 17¾

RS

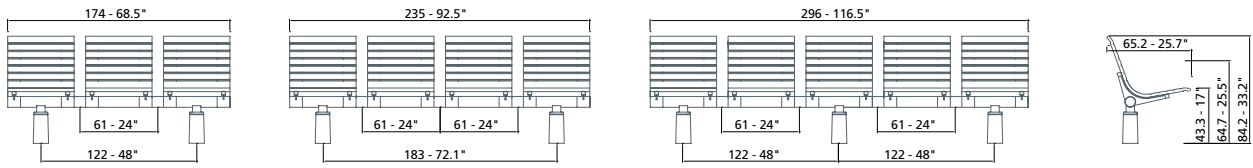

Aluminium backrest seat with direct floor fixing base

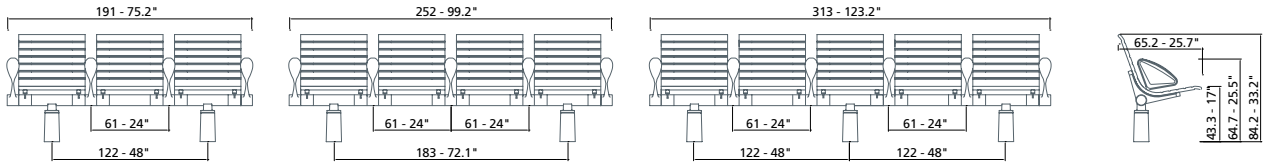

Aluminium backrest seat with armrest and direct floor fixing base

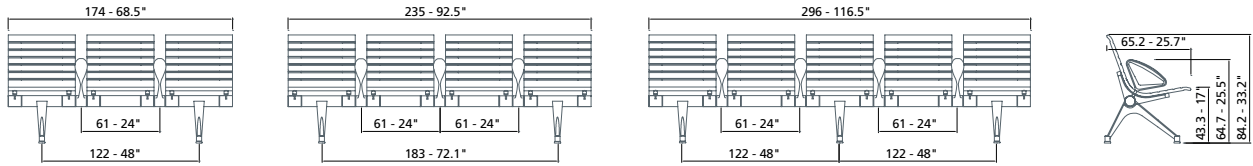

Aluminium backrest seat with armrest and mobile base

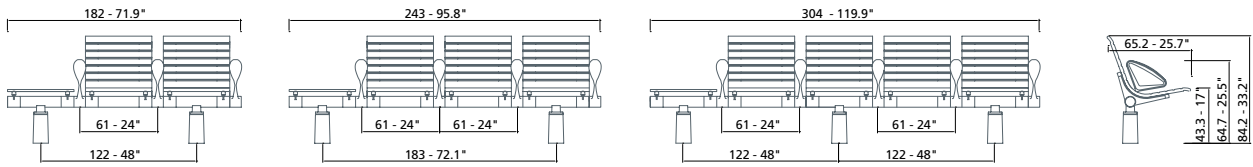

Aluminium backrest seat with table

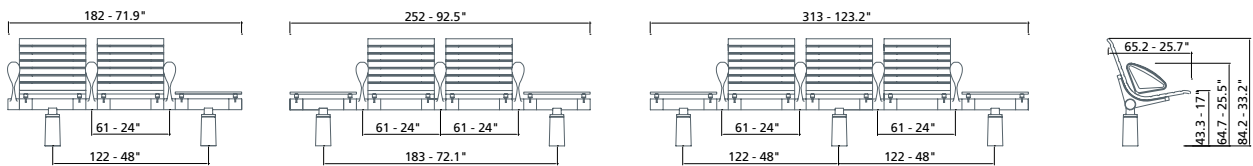

Aluminium backrest seat with tables

RS

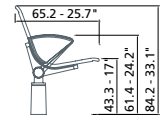
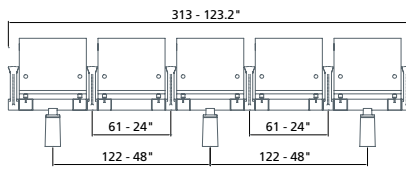
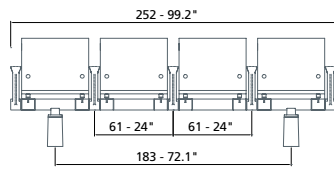
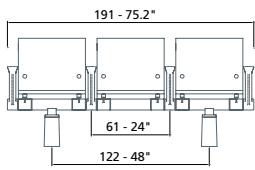

Curved wood seat

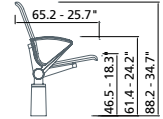
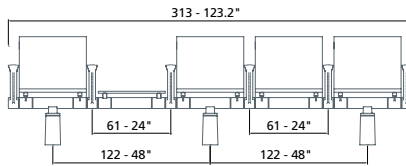
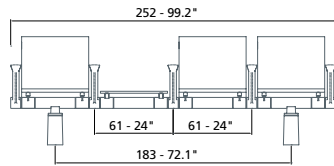
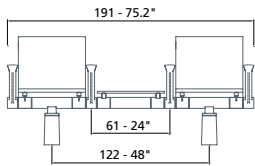

Leather seat with table

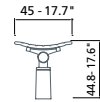
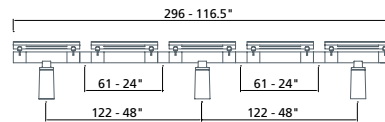
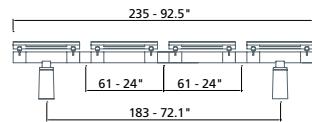
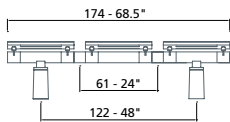

Backless seat

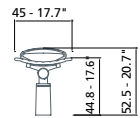
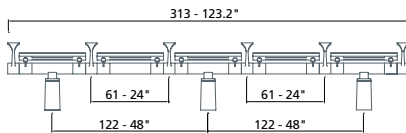
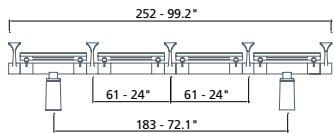
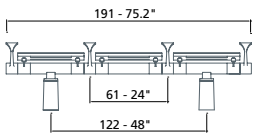

Backless seat with armrest

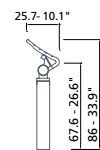
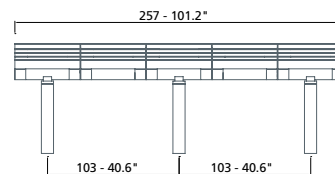
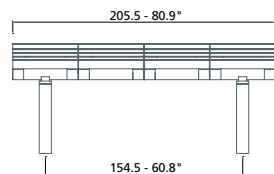
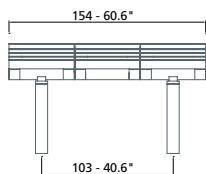

High seat

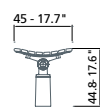
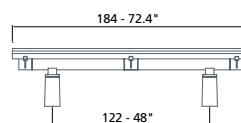
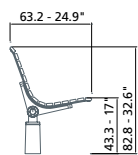
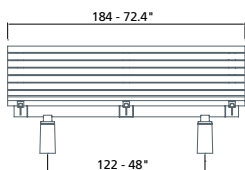

Bench

RS

SHELL 1RS5511, 1RS5541, 1RS5571, 1RS5591



GREY TEXTURIZED

SHELL 1RS5551



TEAK



WENGÈ

SHELL 1RS5561



BLACK LEATHER

STRUCTURES AND BASES



GREY TEXTURIZED

TABLES



BLACK SOLID LAMINATE



ORANGE PAINTED EXTRA LIGHT
TEMPERED GLASS

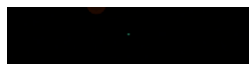

DARK GREY PAINTED EXTRA
LIGHT TEMPERED GLASS